

HWB Series

Hydraulic Drive – Triplex Plunger Pump

FEATURES

- Innovative drive design eliminates need for auxiliary hydraulic drive
- Forged brass manifold
- Built-in Pump Thermal Protection
- No scheduled maintenance required
- Longer life low and high pressure seals
- Pressure trapping unloader included

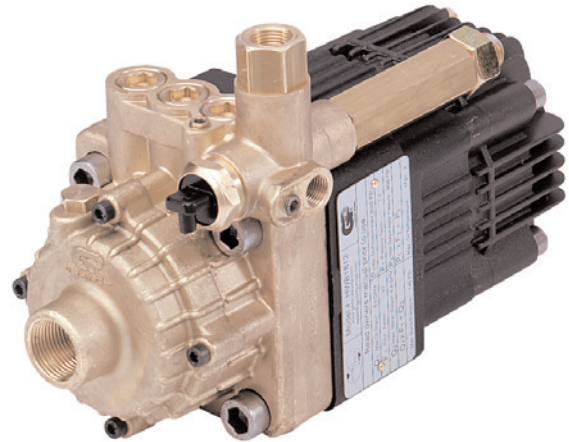

SPECIFICATIONS

Pump Model	HWB2512	HWB2112	HWB1812	HWB1512
Max. Discharge Volume	8.6 GPM	6.6 GPM	4.4 GPM	3.3 GPM
Max. Discharge Pressure	2175 PSI	2900 PSI	3625 PSI	4350 PSI
Maximum Fluid Temp.	145°F			
Minimum Inlet Pressure	-9 ft.			
Maximum Inlet Pressure	150 PSI			
Inlet Port Thread	3/4" NPT-F			
Discharge Port Thread	3/8" NPT-F			
Flow Factor	1.3	1.0	0.67	0.5
Pressure Factor	0.6	0.8	1.2	1.75
Max. Hydraulic Pressure	3625	3625	3020	2485
Max. Oil Supply Volume	6.6 GPM			
Minimum Oil Supply	3.2 GPM			
Max. Hyd. Return Press.	145 PSI			
Max. Oil Temperature	176° F			
Hydraulic Inlet Port Size	1/2" BSPP-F			
Hydraulic Return Port Size	1/2" BSPP-F			
Weight	19 lbs.			
Dimensions	11.2 x 4.7 x 7.0 in.			

PERFORMANCE

Flow Conversion Chart

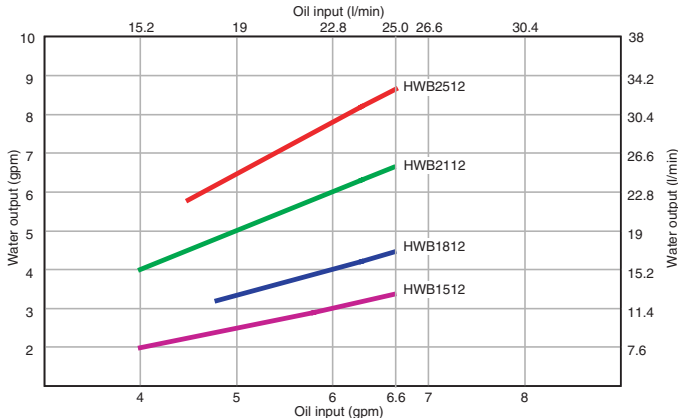

Pressure Conversion Chart

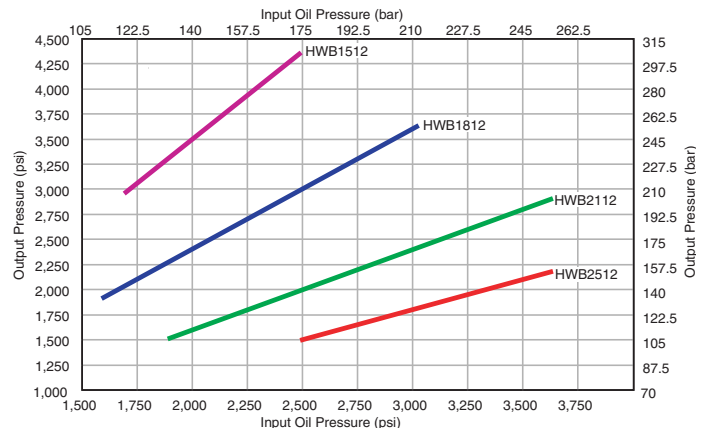

HWB Series

GENERAL PUMP A member of the Interpump Group

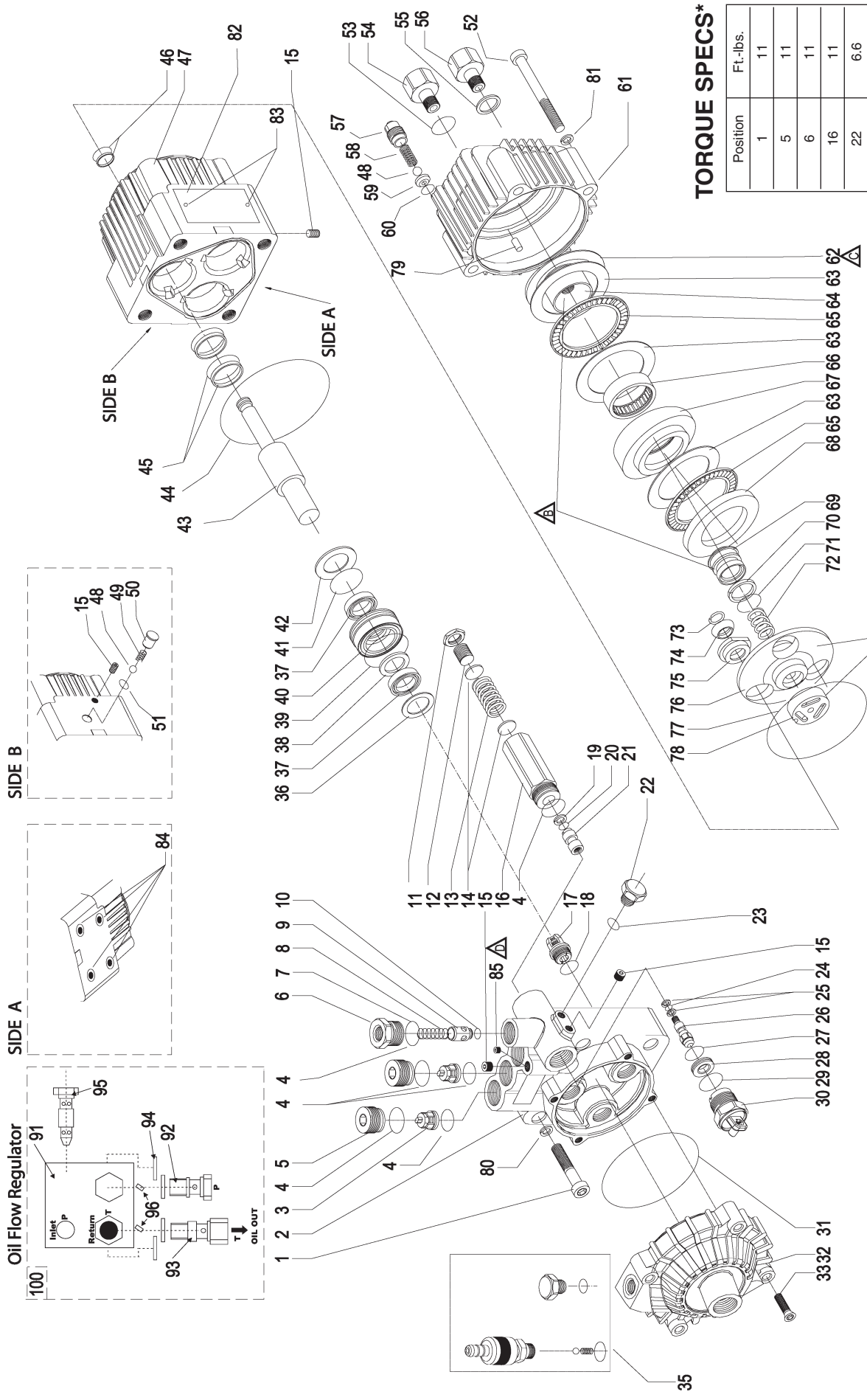

TORQUE SPECS*

Position	Ft.-lbs.
1	1.1
5	1.1
6	1.1
16	1.1
22	6.6
33	6.6
35	6.6
52	7.7

- A. Order kit P320. To guarantee proper performance, parts are factory-mated and must be replaced as a set.
- B. Order kit P330. To guarantee proper performance, parts are factory-mated and must be replaced as a set.
- C. Drive must be properly shimmed after disassembly. An authorized technician must perform shimming operation. Failure to shim drive correctly will result in premature wear and/or failure. Improper shimming will void warranty.
- D. Orifice (ref. 85) is only present in HWB1512 and HWB1812 models. No service required. Specify pump model when ordering replacement manifold (ref. 2).

*Decrease torque by 20% if threads are lubricated.

SCHEMATIC

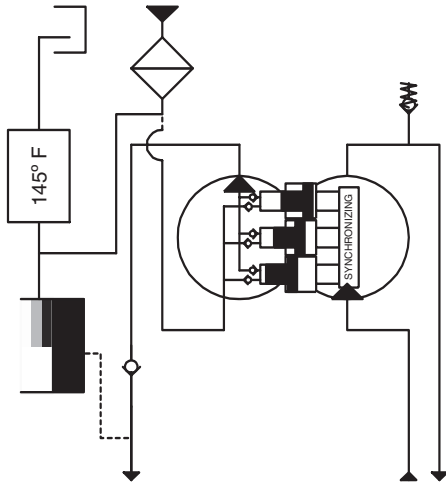

DIMENSIONS & PORTS

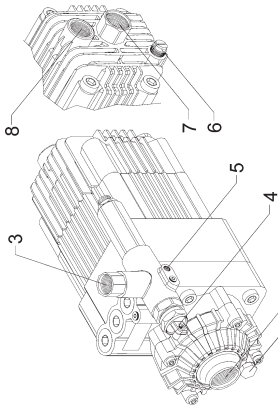

- 1. Inlet 3/4" NPT-F
- 2. Chemical Injector . . M12 x 1
- 3. Discharge 3/8" NPT-F
- 4. Thermal Protector
- 5. Gauge Port 1/4" G-F
- 6. Relief Valve
- 7. Oil Inlet 1/2" G-F
- 8. Oil Return 1/2" G-F

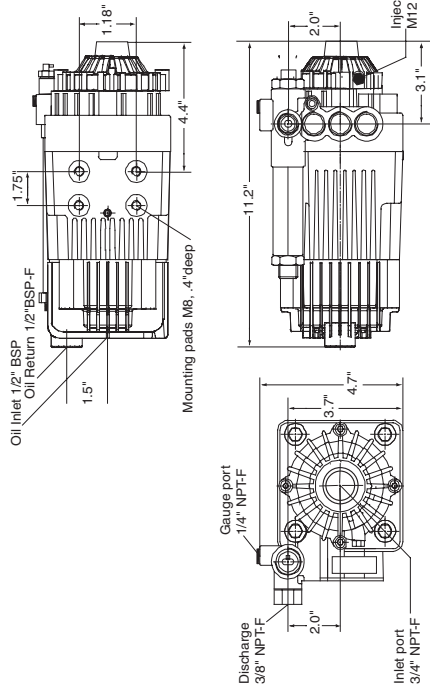

ACCESSORIES

Flat Face Hydraulic Couplers

	HFFQ001	HFFQ002	HFFQ003	HFFQ004
Type	Plug	Coupler	Plug	Coupler
Ports	1/2" NPT-F x 1/2" QC-M	1/2" QC-F x 1/2" BSP-M	1/2" BSP-M x 1/2" QC-M	1/2" NPT-F x 1/2" QC-F
Max Flow	14 GPM			
Max Pressure	4350 PSI			
Operating Temp Range °F	-40° to +250°F			
Weight	1.0 lb.			



- Flat-Face Style for Easy Cleaning
- Locking Feature Reduces Risk of Accidental Disconnect
- Minimal Fluid Loss when Connected and Disconnected
- Heavy-Duty Carbon Steel, Zinc-Coated Construction
- Increased Bearing Points Reduce Brinelling

Nozzles



- Available in Three Styles
 - S - 1/8" NPT-M
 - M - 1/4" NPT-M
 - Q - 1/4" QC-M
- Pressure Rated to 5000 psi

- Permanent Laser Marked Identification
- Hardened 303 Stainless Body with Through-Hardened SS Insert for Maximum Wear Resistance

Gun/Wand



YRL55L

- Complete Gun/Wand Assembly
- 36" Insulated Lance
- Max Flow 7.8 gpm
- Max Pressure 5100 psi

Gauge



320001

- 0-5000 Dual Scale psi/bar
- Glycerin Dampened

Hose Reels



- Hold up to 150' of 3/8" Hose
- Max Pressure 3500 psi

Part Number	Capacity
D30001	50' x 3/8"
D30002	100' x 3/8"
D30004	150' x 3/8"

OPERATION AND INSTALLATION

POSITIONING

The HWB pump can be mounted in any orientation but consider the water supply when installing the pump keeping in mind feed and plumbing requirements. The pump must be mounted to a rigid and flat base using the four threaded feet in the body. Never install the pump such that the fluid end rests on the base on which the pump is mounted. The fluid end must be left free and not subject to any force.

WATER LINE CONNECTIONS

In order to isolate any pump vibration, use flexible hoses for both the inlet and discharge lines. The flexible inlet hose must be rigid enough not to collapse during the suction stroke, when a partial vacuum may occur.

PUMP FEEDING

HWB series pumps require a minimum inlet pressure at the inlet port. HWB pumps operate between -9 ft of inlet pressure to a maximum inlet pressure of 150 psi.

If the above conditions cannot be met a feed pump (centrifugal type) may be required and must:

- (1) supply at least twice the plunger pump volume at the required pressure,
- (2) operate independently and
- (3) supply its full rated performance even if the plunger pump is run below its rated performances.

INLET LINE

THE INLET LINE MUST HAVE THE FOLLOWING CHARACTERISTICS:

- Minimum internal diameter of 1".
- Minimize all 90° elbows, diameter reductions, counter slopes and T-connections, and none of these fittings in the inlet piping within 12 inches of the inlet port.
- Be positioned so that it remains filled after the pump stops.

Recommendations:

- Do not use high-pressure flexible hose for the inlet line.
- Install an inlet pressure gauge after the filters and as close as possible to the pump inlet port.
- Be sure that the supply tank dimensions and the minimum water level do not create turbulence at the pump inlet port.
- Recommended minimum tank volume is five times discharge flow rate.
- Baffle plates should be inside the tank.
- Before connecting the suction line to the pump inlet port be sure the line is clean inside.
- A low water cut-out should be installed to prevent the pump from running dry
- On systems with a high oil capacity a flow regulator should be installed to protect the pump from over-running

FILTRATION

HWB pumps require 80 mesh filtration.

The filters should be installed as close as possible to the pump, allow easy inspection and have the following characteristics:

- The capacity of each filter must be at least 3 times the rated pump volume.
- Filter port diameters should not be smaller than the pump inlet ports.

IMPORTANT NOTE: Clean the filters daily, more often in poor water conditions, to prevent premature pump wear and damage.

START-UP CHECKS

NOTE: If pump has not been operated for a long period of time, check the inlet and discharge lines for scaling.

START-UP AND OPERATION

- Make sure the correct inlet pressure is provided.
- Set the regulating valve to zero or set the discharge line into the dump mode.
- Be sure that the correct inlet pressure is provided.
- Before putting the pump under pressure, let the pump run for some time until the water flows freely.
- After stopping the pump, relieve the pressure from the system.